

Dolch.
Computer Systems, Inc.

FieldPAC

CONTRACT NO.		N/A		DRAWING NO.		REV.
REFERENCE ONLY		SIZE	FSCM	5005	C	
All dimensions in inches unless otherwise noted.		SCALE	NONE			SHEET 1 OF 5

16.00

150°
Max

USB
Port

Ethernet
Port

PCI/ISA
Add-In
Card
I/O Opening

Com 1 Serial Port

Com 2 Serial Port

External Video

PCMCIA/Cardbus
Slots

Microphone In

Line In

Speaker Out

Volume Control

On/Off Switch

Dolch.
Computer Systems, Inc.

FieldPAC

CONTRACT NO. N/A

REFERENCE ONLY
SIZE A

FSCM

DRAWING NO. 5005

REV. E

All dimensions in inches unless otherwise noted.

SCALE NONE

SHEET 2 OF 6

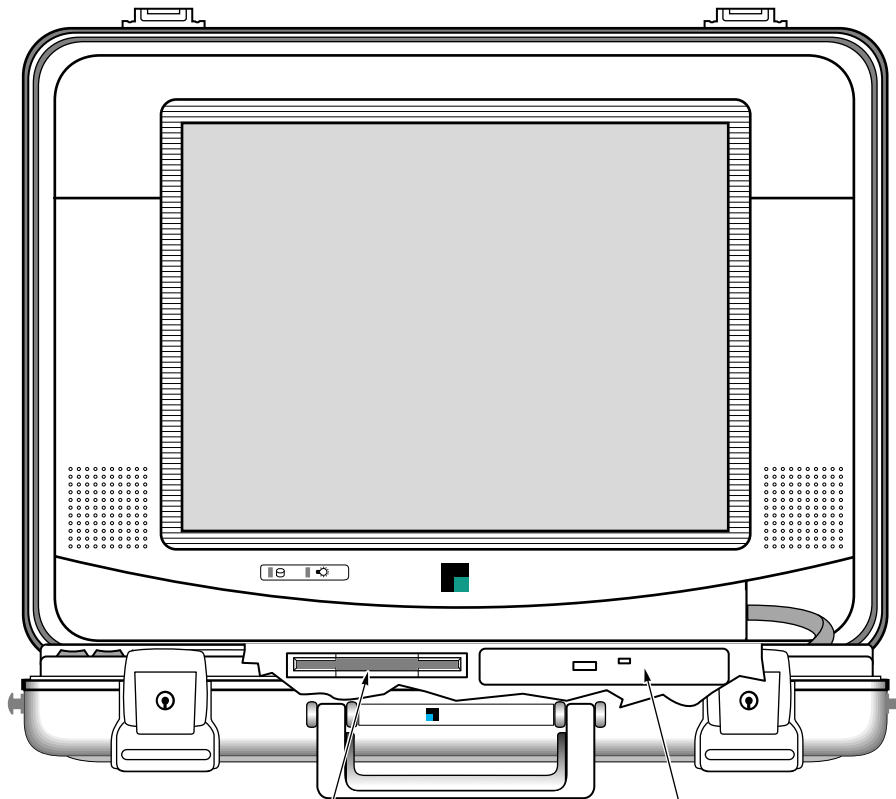

Floppy Drive

CD ROM Drive

Cutaway Showing Peripheral Drives

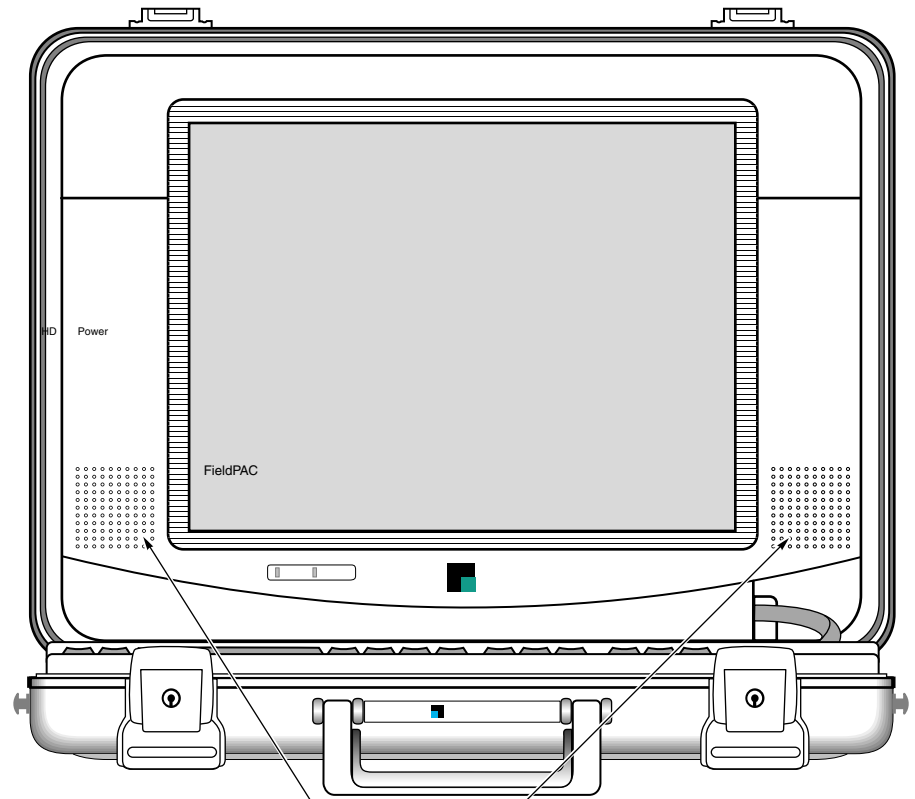

Stereo Speakers

Dolch. Computer Systems, Inc.				
FieldPAC				
CONTRACT NO.	N/A		DRAWING NO.	5005
REFERENCE ONLY	SIZE	FSCM	REV.	E
	A			
All dimensions in inches unless otherwise noted.		SCALE	NONE	SHEET 3 OF 5

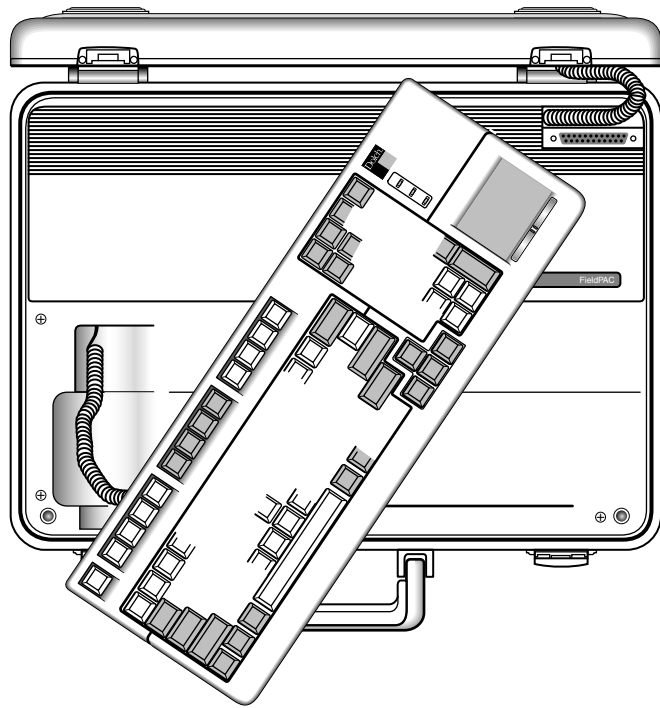

Add-in card
installs underneath
removable keyboard

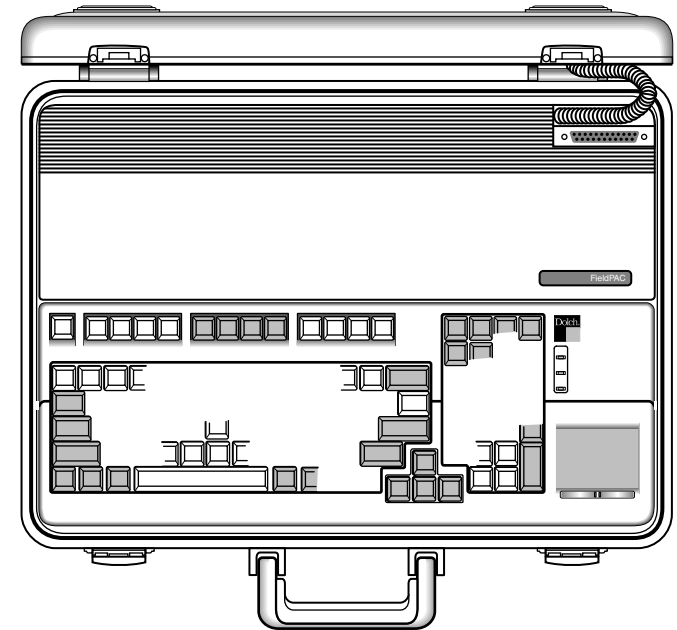

Standard Keyboard

104/105-key keyboard
Sealed VersaPad pointing device

Standard AC Power Supply

Input voltage: 90VAC to 264VAC auto-ranging
Input frequency: 47Hz to 63Hz
Inrush current: 45A max at 264VAC

Load Range:

Output	Max.	Load Regulation
+5VDC	12A	±1%
+12VDC	4A	±5%
-5VDC	0.5A	±5%
-12VDC	0.5A	±5%

Output power: 100W total DC continuous power

Power receptacle: IEC 320/CEE 22 compliant

Environmental Specifications Applicable to All Processors and Displays

System weight 15 lb

Shock (Per MIL-STD-810E paragraph 516.5 procedure I)

Operating 15g 11ms sine
Non-operating 30g 11ms sine

Transit Drop

48", 26 Drops in transit case or shipping carton per MIL-STD-810E paragraph 516.4 procedure IV

Bench Handling

4", 4 unprotected drops per MIL-T-28800E paragraph 3.7.5.3 and 4.5.5.4.3

Vibration (Per IEC 68-2-6)

Operating 10-58Hz 0.03" displacement
58-500Hz 10g
Non-operating 10-58Hz 0.14" displacement
58-500Hz 50g

Temperature

Operating 0° to +50° C
Non-operating -20° to +70° C

Humidity

Operating 5% to 95% non-condensing
Non-Operating 5% to 95% non-Condensing

Altitude

Operating (1 Hour) -1,000 to +15,000 Feet (-305 to +4,572 meter)
Non-operating (2 Hour) -1,500 to +40,000 Feet (-457 to +12,192 meter)

Preliminary

Dolch.
Computer Systems, Inc.

CONTRACT NO.		N/A		FieldPAC		
REFERENCE ONLY		SIZE	FSCM	DRAWING NO.	5005	REV.
All dimensions in inches unless otherwise noted.		A				
		SCALE	NONE			SHEET 4 OF 5

Removable Saddlebag and Separately Removable Shoulder Strap

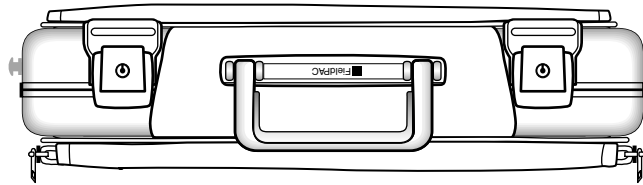

Removable Strap
See Inset

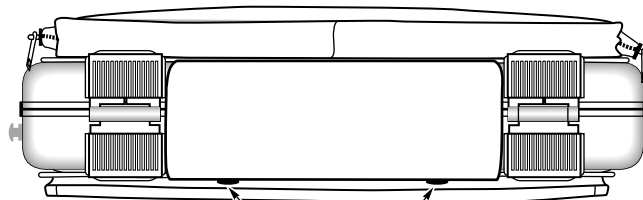
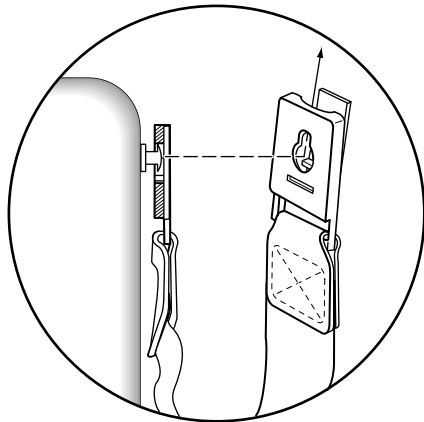
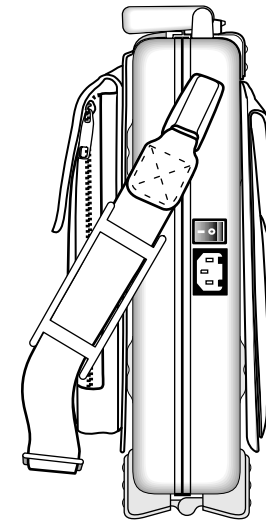
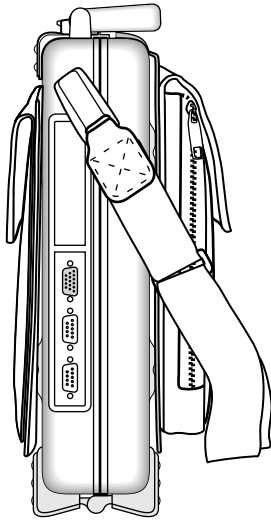
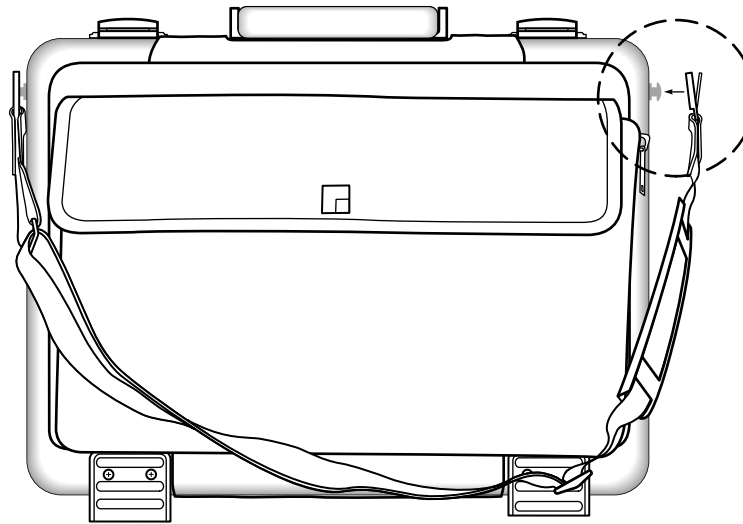

Snaps Securing Saddlebag

Dolch.
Computer Systems, Inc.

FieldPAC

CONTRACT NO.		N/A		DRAWING NO.		REV.	
REFERENCE ONLY		SIZE	FSCM	5005		E	
All dimensions in inches unless otherwise noted.		SCALE	NONE			SHEET 5 OF 5	